

MATRAXS

HFT

ÇOK DÜŞÜK GECİKMELİ ALGORİTMİK İŞLEM SİSTEMLERİ

Kapsam

Çok düşük gecikmeli olarak borsa verisi işleme ve emir
iletme

Gerçek borsa verileri ile simülasyon ve algoritma testi



Kullanım Yerleri

Yüksek Frekanslı Algoritmik İşlem

Algoritma Backtesti

Piyasa Yapıcılık

Kurumsal Algoritmalar

Arbitraj Trading

Pair Trading



FONKSİYONLAR

Çok düşük gecikme ile;

Piyasa verisi işleme

LOB-II, LOB-III

Algoritma API

Emir iletimi

Emir durumu takibi



MATRİKS HFT

Desteklenen Teknolojiler

1

ITCH

BIST ve VIOP için çok düşük gecikmeli doğrudan piyasa erişimi.

4

NIC

Kernel by-pass NIC (network kartı) ile entegre.

2

GLIMPSE

GLIMPSE desteği ve yönetimi

5

FGPA

FPGA katmanında geliştirme

3

MULTI-CORE OUCH

Multi-core OUCH inbound /outbound mesaj yönetimi

6

YÖNETİM PANELİ

WEB tabanlı yönetim paneli sayesinde uzaktan kontrol imkanı

MATRİKS HFT

Modüler Yapı

1

PİYASA BAĞLANTISI

FPGA NIC: TCP/IP blođu
ITCH parsing

2

PİYASA VERİSİ

Limit Order Book
Trade Book
Özel tasarım sinyaller

3

STRATEJİ

Sinyal bazlı call-back
C / C++ ile kodlama

4

EMİR YÖNETİMİ

OUCH parser – deparser
Emir durum takibi ile stratejiyi besleme

MATRİKS HFT

Gecikme Performansı



ITCH verisi işleme + LOB oluşturma + strateji çalıştırma + OUCH emir iletimi kablodan kabloya (wire-to-wire)

< 2.5 us toplam gecikme.

Jitter: gecikmenin tutarsızlığı, medyan değerden sapma

%99.9 gecikme dağılımı (percentile) < 3.5 us.

MATRİKS HFT

FPGA Desteđi



Şu anda;

Kernel by-pass ve 10G network socket fonksiyonları.

Test aşamasında;

MOLDUDP64 paketleri ve ITCH mesajları parsing,
ITCH mesajlarını filtreleme,
Limit order book oluşturma,

Planlanan;

OUCB deparser
Algoritmaların FPGA bloğunda çalıştırılması

MATRİKS HFT GEN 1



Borsa İstanbul

Layer1 / Layer2 Switch

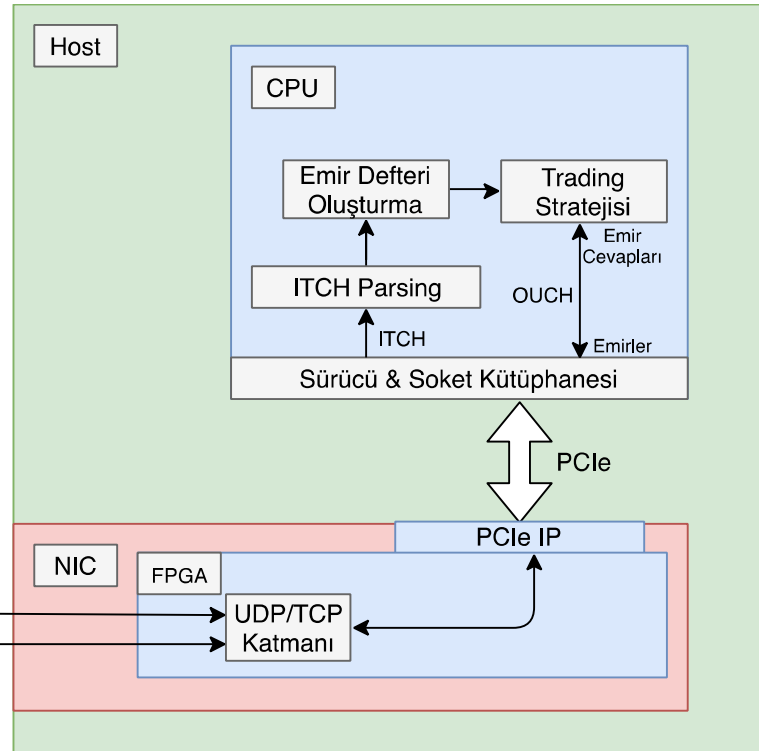

MATRİKS HFT GEN 2



Borsa
İstanbul



Layer1 / Layer2
Switch

OUCH

ITCH

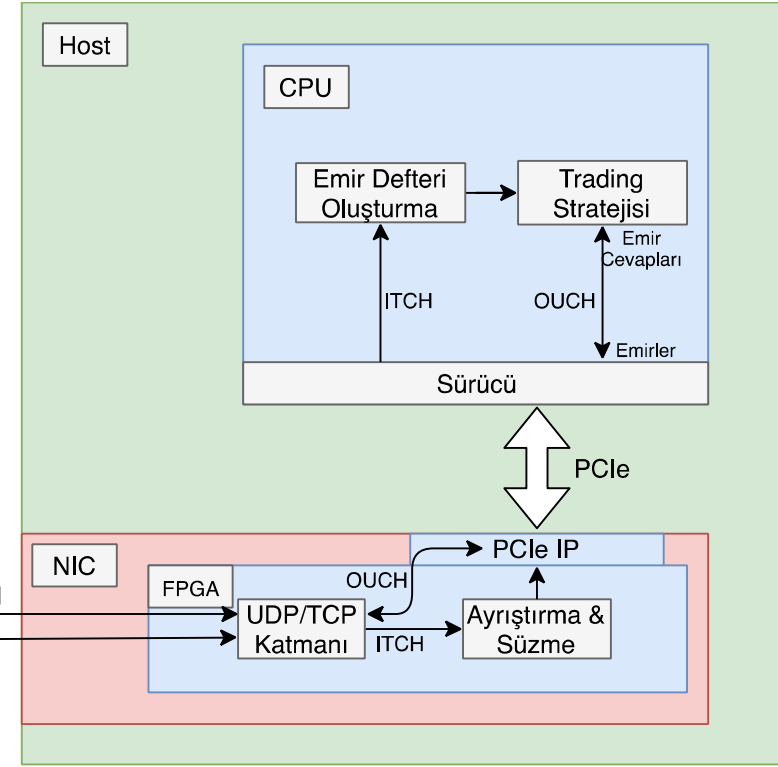

MATRİKS HFT GEN 3



Borsa İstanbul

Layer1 / Layer2 Switch

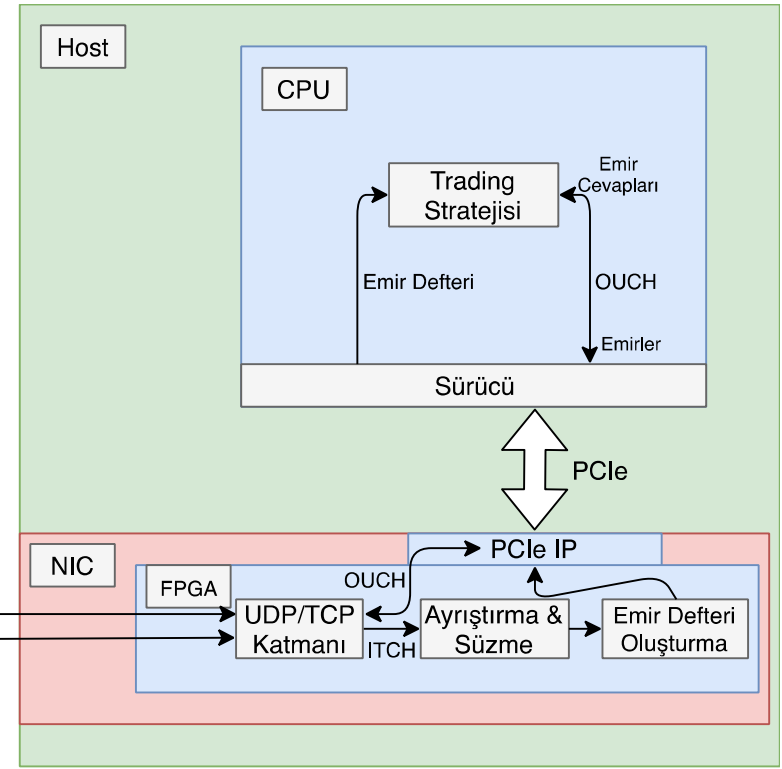

MATRİKS HFT

YAZILIM / DONANIM OPTİMİZASYONU

Sunucu bileşenleri optimizasyonu

İşletim sistemi düzeyinde optimizasyon

Veri yapısı ve algoritma optimizasyonu

Network optimizasyonu: BIST kolokasyon ağ bağlantıları Layer 2 ve 3 düzeyinde test edildi.

FPGA - Host (CPU) iş dağılımı optimizasyonu



MATRİKS HFT

İZLEME / ÖLÇME / MÜDAHELE

Switch düzeyinde gerçekçi gecikme ölçümü

Performans eksiltmeyen loglama

Kullanıcı izleme ve müdahale arayüzü



MATRİKS HFT

CANLI STRATEJİ EKLANLARI

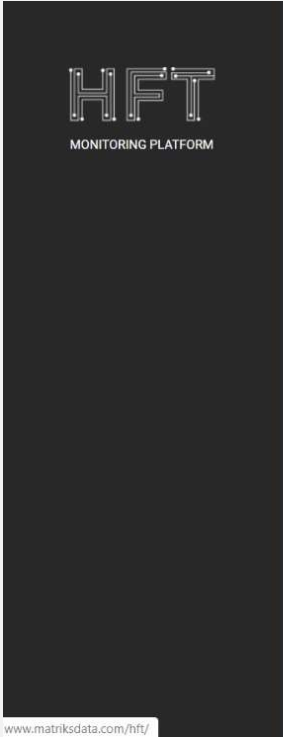

GİRİŞ EKRANI

Kullanıcı Adı

Şifre

Son kurum seçimi ve kullanıcı adımı hatırla

Temizle Giriş

MATRIKS HFT

CANLI STRATEJİ EKРАНLARI







HFT
MONITORING PLATFORM

Sistemi Kapat



Sistem Zamanı :
24.03.2020 13:29:24



Kayıtlı Stratejiler

Search:

Strateji Adı	Açıklama	Aksiyonlar
MMStrategy	Market Maker Stratejisi	 
WebStrategy	WebSocket Test Stratejisi	 
Equity Strategy	Trade based on your equity	 

 Acil Durdur

Order List  Strategy Variables 

Strategy Mesajları  MTX HFT Log 

MATRİKS HFT

CANLI STRATEJİ EKLANLARI

HFT
MONITORING PLATFORM

Sistemi Kapat

Sistem Zamanı :
24.03.2020 13:30:03

Cross Mov Stratejisi Parametre Girdileri

Strategy Adı: Equity Strategy

Durum:

Açıklama: Trade based on your equity

Semboller: F_XU0301219, F_XU0300220

Müşteri No: 111

Strateji Parametreleri

strategy_qty: 100	bid_switch: 00
ask_switch: 00	bid_point: 30000
ask_point: 50000	retreat_lot: 500

PTRM Parametreleri

throttle_limit: 500	pending_qty_limit: 1500
traded_qty_limit: 50000	

Kapat Değişiklikleri Kaydet

Search:

Aksiyonlar

Strategy Variables

MATRİKS HFT

CANLI STRATEJİ EKLANLARI

HFT
MONITORING PLATFORM

Sistemi Kapat

Sistem Zamanı :
24.03.2020 13:30:38

Cross Mov Stratejisi Parametre Girdileri

Strategy Adı: WebStrategy

Durum:

Açıklama: WebSocket Test Stratejisi

Semboller: ASELS.E

Müşteri No: 321

Strateji Parametreleri

strategy_qty	strategy_qty_limit
250	480000

PTRM Parametreleri

throttle_limit	pending_qty_limit
50	750
traded_qty_limit	
480000	

Kapat Değişiklikleri Kaydet

Search:

Aksiyonlar

Strategy Variables

MATRİKS HFT

CANLI STRATEJİ EKLANLARI

Order List

Excele Aktar

Search:

Strateji Adı	Sembol	İşlem	Tarih	Token	Alış/Satış	Emir No	Miktar	Fiyat	TIF	Durum
Lütfen Seçin	Lütfen Seçin	Lütfen Seçin								
WebStrategy	ASELS.E	Order Accepted	28.02.2020 12:21:320.472	880665	Sell	1	250	17560	Day	
WebStrategy	ASELS.E	Order Executed	28.02.2020 12:21:320.472	880665						
WebStrategy	ASELS.E	Enter Order	28.02.2020 12:21:320.47	880665	Sell		250	17560	Day	
WebStrategy	ASELS.E	Order Accepted	28.02.2020 12:21:300.03	880664	Buy	1	250	17550	Day	
WebStrategy	ASELS.E	Order Executed	28.02.2020 12:21:300.03	880664						
WebStrategy	ASELS.E	Enter Order	28.02.2020 12:21:300.02	880664	Buy		250	17550	Day	
WebStrategy	ASELS.E	Order Accepted	28.02.2020 12:20:590.117	880663	Buy	1	250	17560	Day	
WebStrategy	ASELS.E	Order Executed	28.02.2020 12:20:590.117	880663						
WebStrategy	ASELS.E	Enter Order	28.02.2020 12:20:590.116	880663	Buy		250	17560	Day	
WebStrategy	ASELS.E	Order Accepted	28.02.2020 12:20:560.07	880662	Sell	1	250	17570	Day	

Previous 1 2 3 4 5 ... 17 Next

Strategy Mesajları

Search:

Strateji Adı	Tarih	Mesaj
WebStrategy	28.02.2020 12:23:030.44	BUY Order Fully Executed. prc:17550 New BUY order will be entered.
WebStrategy	28.02.2020 12:22:450.532	SELL Order Fully Executed. prc:17560 New SELL order will be entered.
WebStrategy	28.02.2020 12:22:320.05	BUY Order Fully Executed. prc:17560 New BUY order will be entered.
WebStrategy	28.02.2020 12:22:090.469	SELL Order Fully Executed. prc:17570 New SELL order will be entered.
WebStrategy	28.02.2020 12:22:010.871	BUY Order Fully Executed. prc:17550 New BUY order will be entered.
WebStrategy	28.02.2020 12:21:320.471	SELL Order Fully Executed. prc:17560 New SELL order will be entered.
WebStrategy	28.02.2020 12:21:300.03	BUY Order Fully Executed. prc:17550 New BUY order will be entered.
WebStrategy	28.02.2020 12:20:590.117	BUY Order Fully Executed. prc:17560 New BUY order will be entered.
WebStrategy	28.02.2020 12:20:560.07	SELL Order Fully Executed. prc:17570 New SELL order will be entered.
WebStrategy	28.02.2020 12:20:280.51	BUY Order Fully Executed. prc:17580 New BUY order will be entered.

Previous 1 2 3 4 5 6 7 Next

MATRIKS HFT

CANLI STRATEJİ EKLANLARI

Kayıtlı Stratejiler

Order List

Strategy Variables

Strategy Mesajları

MTX HFT Log

Search:

Search:

Strateji Adı	Tarih	Mesaj
WebStrategy	28.02.2020 12:26:440.167	BUY Order Fully Executed, prc:17570 New BUY order will be entered.
WebStrategy	28.02.2020 12:26:230.725	SELL Order Fully Executed, prc:17590 New SELL order will be entered.
WebStrategy	28.02.2020 12:26:130.57	BUY Order Fully Executed, prc:17570 New BUY order will be entered.
WebStrategy	28.02.2020 12:25:460.889	SELL Order Fully Executed, prc:17580 New SELL order will be entered.
WebStrategy	28.02.2020 12:25:410.192	BUY Order Fully Executed, prc:17580 New BUY order will be entered.
WebStrategy	28.02.2020 12:25:100.51	BUY Order Fully Executed, prc:17580 New BUY order will be entered.
WebStrategy	28.02.2020 12:25:100.51	SELL Order Fully Executed, prc:17590 New SELL order will be entered.
WebStrategy	28.02.2020 12:24:380.206	BUY Order Fully Executed, prc:17560 New BUY order will be entered.
WebStrategy	28.02.2020 12:24:340.412	SELL Order Fully Executed, prc:17580 New SELL order will be entered.
WebStrategy	28.02.2020 12:24:070.468	BUY Order Fully Executed, prc:17550 New BUY order will be entered.

Previous 1 2 3 4 5 - 8 Next

Tarih	Seviye	Mesaj
28.02.2020 12:11:570.315	WARNING	GUIServer: LoginAccepted - Username : Veil-Kupeli
28.02.2020 12:09:220.681	WARNING	GUIServer: LoginAccepted - Username : Veil-Kupeli
28.02.2020 12:06:020.383	INFO	GUIServer: Degisiklikler strateji (strategy.cfg) dosyasina yazildi.
28.02.2020 12:05:000.979	WARNING	GUIServer: LoginAccepted - Username : Veil-Kupeli
28.02.2020 12:03:520.533	WARNING	GUIServer: LoginAccepted - Username : Veil-Kupeli
28.02.2020 12:03:330.579	ERROR	TcpClient:disconnect: TCP client disconnected. host:11.0.0.1 port:21811
28.02.2020 12:03:330.547	INFO	End of snapshot GlimpseOne seq num =0000000000000065883'
28.02.2020 12:03:330.536	INFO	End of snapshot GlimpseFour seq num =00000000000000225919'
28.02.2020 12:03:330.536	ERROR	TcpClient:disconnect: TCP client disconnected. host:11.0.0.1 port:21814
28.02.2020 12:03:320.644	ERROR	TcpClient:disconnect: TCP client disconnected. host:11.0.0.1 port:21813

Previous 1 2 3 4 5 Next

MATRIKS HFT

CANLI STRATEJİ EKLANLARI

MTX HFT Log

Search:

Tarih	Seviye	Mesaj
28.02.2020 12:11:570.315	WARNING	GUIServer: LoginAccepted - Username : Veli-Kupeli
28.02.2020 12:09:220.681	WARNING	GUIServer: LoginAccepted - Username : Veli-Kupeli
28.02.2020 12:06:020.383	INFO	GUIServer: Degisiklikler strateji (strategy.cfg) dosyasina yazildi.
28.02.2020 12:05:000.979	WARNING	GUIServer: LoginAccepted - Username : Veli-Kupeli
28.02.2020 12:03:520.533	WARNING	GUIServer: LoginAccepted - Username : Veli-Kupeli
28.02.2020 12:03:330.579	ERROR	TcpClient::disconnect: TCP client disconnected. host:11.0.0.1 port:21811
28.02.2020 12:03:330.547	INFO	End of snapshot GlimpseOne seq num =0000000000000065883'
28.02.2020 12:03:330.536	INFO	End of snapshot GlimpseFour seq num =00000000000000225919'
28.02.2020 12:03:330.536	ERROR	TcpClient::disconnect: TCP client disconnected. host:11.0.0.1 port:21814
28.02.2020 12:03:320.644	ERROR	TcpClient::disconnect: TCP client disconnected. host:11.0.0.1 port:21813

Previous **1** 2 3 4 5 Next







Strategy Variables

WebStrategy

Buy Price	Buy Qty	Buy Order Count
17550	250	31
Sell Price	Sell Qty	Sell Ord.Cnt.
17570	250	27
Total Buy Qty	Total Sell Qty	Grand Total
7750	6750	14500

Kayıtlı Stratejiler

Search:

Strateji Adı	Açıklama	Aksiyonlar
MMStrategy	Market Maker Stratejisi	 
WebStrategy	WebSocket Test Stratejisi	 
VeliStrategy	Veli ve Islam tarafından geliştirilen ilk strateji	 

 Acil Durdur



MATRAXS

HFT

TEST / BACKTEST SUITE

MATRİKS HFT

TEST / BACTEST SUITE

Amaç;

Kolokasyonda canlıya almadan önce test

Piyasa yayını ve emir gönderme testi,

Algoritma backtesti,

Sistem ve işlevsellik testi yapabilecek bir destek sistemi.



MATRİKS HFT

TEST / BACTEST SUITE

Tarihsel MOLDUDP64 paketlerinde ITCH yayını
(BİST'in yayınladığı paketlerin aynısı)

Gerçekçi GLIMPSE sunucusu

OUCH sunucusu –matching engine simulasyonu.

Gerçeğe yakın limit emir ve piyasa emri takibi



MATRİKS HFT

TEST / BACTEST SUITE

Pythonda tam derinlikli emir ve trade defterine baęlı strateji yazabilme

HFT platformlarında veya Python'da trading algoritma backtesti

Planlanan

Trading performans raporları, grafikleri



MATRİKS HFT

TEST / BACTEST SUITE

Paket yayım hızını (1x, 5x, ..., Max) ayarlayabilme

Tam derinlikli (L2, L3) emir defterlerini saklama

Planlanan

Python 3.x API ile post-trade trading performans ve latency analizi: görselleştirme, raporlama



MATRİKS HFT

BACKTEST EKRANLARI

TEST PARAMETRELERİ

Tarih Seçimi
Tarih seçiniz...

Piyasa Parametreleri
 Pay Piyasası VIOP Piyasası Tüm Piyasaları Dahil Et

Semboller
+

Realtime TH

x1 (16bps) x2 (32bps) x3 (64bps) x4 (128bps) x5 (256bps)

TEST SENARYOLARI

Paket Kaçırma

Saat Aralığı: 15:50:00 - 19:00:00
Data Kaçırma Adeti: 20
Sıklık Parametresi: * bu alana değer girilmesi zorunludur

Parametreleri Sıfırla

Testi Çalıştır

TEST PARAMETRELERİ

Tarih Seçimi
27/08/2019

Piyasa Parametreleri
 Pay Piyasası VIOP Piyasası Tüm Piyasaları Dahil Et
 PP [A-J]
 PP [K-Z]

Semboller
GARAN

Realtime TH

x1 (16bps) x2 (32bps) x3 (64bps) x4 (128bps) x5 (256bps)

TEST SENARYOLARI

Paket Kaçırma

Saat Aralığı: 15:50:00 - 19:00:00
Data Kaçırma Adeti: 20
Sıklık Parametresi: * bu alana değer girilmesi zorunludur

Parametreleri Sıfırla

Testi Çalıştır

MATRİKS HFT

BACKTEST EKRANLARI

TEST PARAMETRELERİ [Simulasyon Timestamp : 16:15:23,16748526]

Tarih Seçimi: 27/08/2019

Piyasa Parametreleri:
 Pay Piyasası VIOP Piyasası Tüm Piyasaları Dahil Et
 PP [A-J] PP [K-Z]

Semboller: GARAN

Realtime TH

x1 (16bps) x2 (32bps) x3 (64bps) x4 (128bps) x5 (256bps)

TEST SENARYOLARI

Parametreleri Sıfırla Testi Durdur

BACKTEST RAPOR SONUCU

Semboller: Raporu filtrelemek için çoklu sembol seçimi yapabilirsiniz... Excele Aktar

All	Long	Short
Total Net Profit	1250	Gross 1400
Total Number of Trades	200	Winning Trades 120 Even Trades 80
Avg. Trade Net Profit	20	Avg. Winning Trade 40 Largest Winning Trade 200 Largest Winner as % of Gross Profit %20
Net Profit as % of Largest Loss	%200	
Max. Consecutive Winning Trades	20	
Return on Initial Capital	%225	
Max. Drawdown Value	300	Max. Drawdown as % of Initial Capital %7 Net Profit as % of Drawdown %20

ORDER LIST

Excele Aktar

Hisse: ASELS DOHOL Order Type: Short Order Status: Active

Hisse	Fiyat	Timestamp	Order Token	Order Type	Quantity	Order Status
ASELS	16,47	16:15:23,16748526	123456	Short	300	Active
ASELS	16,47	16:15:23,16748526	123456	Short	300	Active
ASELS	16,47	16:15:23,16748526	123456	Short	300	Active
DOHOL	16,47	16:15:23,16748526	123456	Short	300	Active
DOHOL	16,47	16:15:23,16748526	123456	Short	300	Active
ASELS	16,47	16:15:23,16748526	123456	Short	300	Active
DOHOL	16,47	16:15:23,16748526	123456	Short	300	Active
ASELS	16,47	16:15:23,16748526	123456	Short	300	Active

ORDER SUMMARY

- 23.08.2019 17:23:00 Asels ortalama 16,23 fiyatından 200 alım gerçekleşti.
- 23.08.2019 17:23:00 Asels ortalama 17,02 fiyatından 300 satış gerçekleşti.
- 23.08.2019 17:23:00 Asels Toplam Gerçekleşen Emir: 500 Asels Toplam Bekleyen Emir: 200
- 23.08.2019 17:23:00 THYAO ortalama 16,23 fiyatından 200 alım gerçekleşti.
- 23.08.2019 17:23:00 THYAO ortalama 17,02 fiyatından 300 satış gerçekleşti.
- 23.08.2019 17:23:00 THYAO Toplam Gerçekleşen Emir: 500 THYAO Toplam Bekleyen Emir: 200

LOGLAR

- Excele Aktar
- 23.08.2019 17:23:00 Fonksiyon ismi: OnOrderUpdate, Detay: Emir Gönderildi, Hesap: 808596, Sell, Emir Tipi: PYS, Sembol: YKBNK, Miktar: 100, Fiyat: 0, Emir id: 000000
- 23.08.2019 17:23:00 Fonksiyon ismi: OnOrderUpdate, Detay: Emir Durumu Değiştiril, Hesap: 808596, Sell, Emir Tipi: PYS, Emir Durumu: Reddedildi
- 23.08.2019 17:23:00 Fonksiyon ismi: OnOrderUpdate, Detay: Emir Gönderildi, Hesap: 808596, Buy, Emir Tipi: PYS, Sembol: YKBNK, Miktar: 100, Fiyat: 0, Emir id: 000000
- 23.08.2019 17:23:00 Fonksiyon ismi: OnOrderUpdate, Detay: Emir Durumu Değiştiril, Hesap: 808596, Buy, Emir Tipi: PYS, Emir Durumu: Reddedildi